

Technical Information (2)

Other Information about Stages
 Stage Selection Table P.1639, P.1640
 New Products P.1641
 About Standard Stages P.1642
 Overview: Technical Information P.1643, P.1644



[Standard] Dovetail Slide, Feed Screw

Other Information about Stages
 Stage Selection Table P.1639, P.1640
 New Products P.1641
 About Standard Stages P.1642
 Overview: Technical Information P.1643, P.1644

Stage Operating Environment

Operating Environment: 10~50°C, 20~70% RH (No Condensation)
 Recommended Operating Environment: 22±5°C, 20~70%RH (No Condensation)

Stage Installation Method

To mount a stage on the base surface, move the top plate to access mounting holes as shown below.

X-Axis Stages

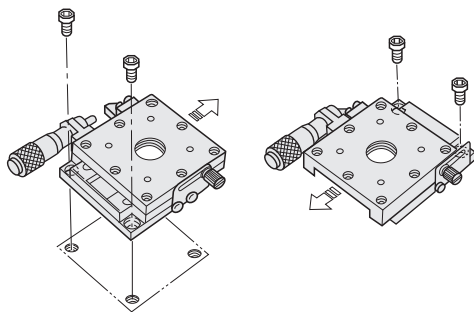

XY-Axis Stages

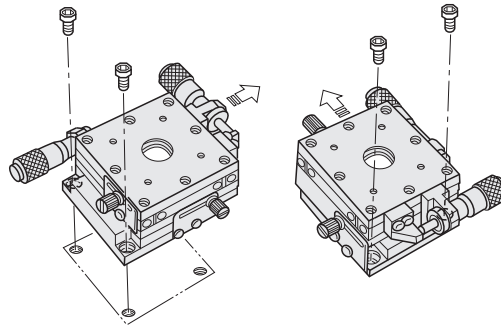

Rotary Stages

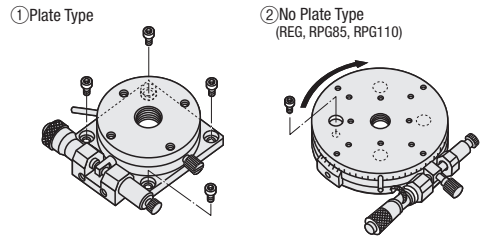

Goniometer Stages

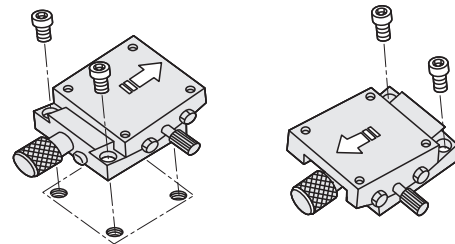

Notes on Mounting Surface Accuracies

Intended product performances may not be achieved if the stage mounting surface or the carried object's mounting surface do not have sufficient flatness. (General Flatness Guideline: 10µm or better)

Vertical Use of X-Axis Stages

When mounting a stage in vertical orientation, note the directions of the feed mechanisms and springs. When installing Linear Ball Slide Stages and Cross Roller Stages, do not select the micrometer head position CR or A with the micrometer head pointing down since the carriage may drop. For the use of the micrometer head pointing down, select CZ to prevent the carriage from falling down.

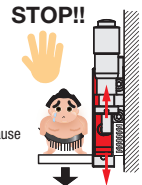
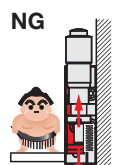
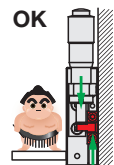

How to mount stages vertically without the carriage drop when Micrometer Head Position Alteration is selected.

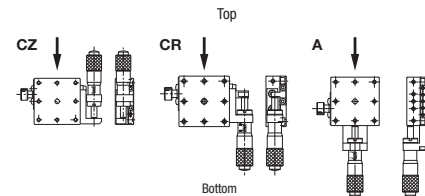

(CZ) The carriage does not drop since the micrometer head tip pushes the bracket on the bottom plate.

(Standard Application) A load exceeding the spring pull force will cause the carriage to drop.

However, do not apply a load exceeding the specified vertical load capacity.

Standard Stages

About Holding Force (Ref.)

Holding Force is the (reference) value to hold the stage top surface rest when clamped.

Measured Holding Force

<Test Conditions> Clamp screws are tightened with the tightening torque below and pressed with the test instrument (F in the diagram). The max. holding force is the load measured where the stage top surface starts to move.

- Tightening Torque (Standard) (a) XDTS (Standard, Dovetail Slide, Rack & Pinion) Size 50 and 60: 0.1N·m; Size 90: 0.15N·m
- (b) XDTS (Standard, Dovetail Slide, Low Profile, Rack & Pinion) Size 50 and 60: 0.1N·m; Size 90: 0.15N·m
- (c) XCRS (Standard, Cross Roller): 0.15N·m

<Max. Holding Force (Ref.)>

Type	Max. Holding Force (Ref.)
(a) XDTS	50: 30N
	60: 60N
	90: 70N
(b) XDTS	50: 10N
	60: 20N
	90: 40N
(c) XCRS	40: 60N
	60: 60N
	80: 70N

<Max. Holding Force (Ref.) depending on Tightening Torque>

Type	Tightening Torque (Standard at 100%)		
	50%	100%	150%
XDTS60	50N	60N	90N
XCRS60	40N	60N	100N

<Testing Method>

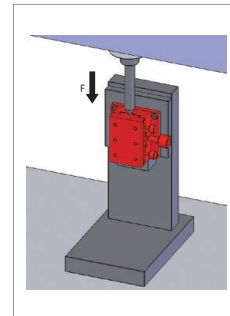

Feature: Stages with 0.5mm fine lead. Existing Products: XEG, XYEG (P1677, 1693)

X-Axis



RoHS

Clamp Position Change XFES_R (Reversed)

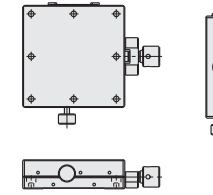

See the CAD data for the details.

XFES25 (Standard)

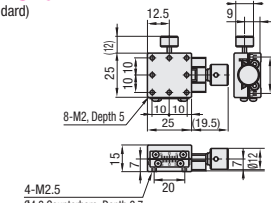

XFES40 (Standard)

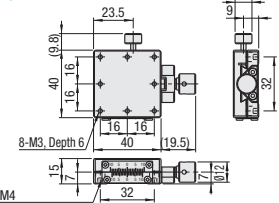

XFES60 (Standard)

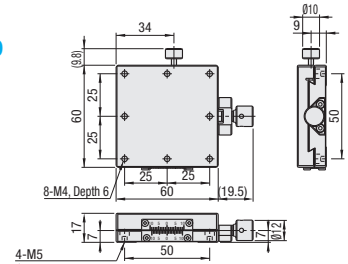

Material: Aluminum Alloy Surface Treatment: Black Anodize

X-Axis Stages High Precision Stage Existing Product: XEG (P1677)

Type	Part No.	Clamp Position	Stage Surface (mm)	Travel Distance (mm)	Travel per Knob Rotation (mm)	Load Capacity (N)		Travel Accuracy Straightness	Weight (kg)	Unit Price 1~9 pc(s).	
						Horizontal	Vertical				
XFES	25	Not Specified (Standard)	25x25	±5	0.5	29.4	9.8	50µm	0.04		
	40	R (Reversed)	40x40	±7		39.2	19.6				0.08
	60	R (Reversed)	60x60	±8							0.18

Resolution (Vernier Scale Indication): 0.1mm/division

Knob Extension Cover HDEXT12_ (Sold Separately): Ø12 knobs can be extended by installing the cover. P1683 (Caution) Please note that increased knob diameter may interfere with the stage mounting base surfaces.

Ordering Example Part Number XFES40

Days to Ship

Configure Online

Price Configure Online

XY-Axis

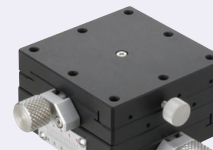

RoHS

Clamp Position Change XYFES_R (Reversed)

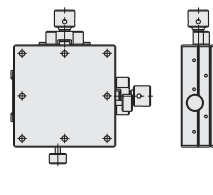

See the CAD data for the details.

XYFES25 (Standard)

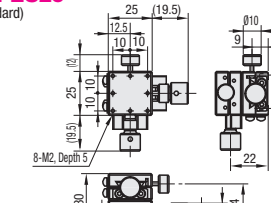

XYFES40 (Standard)

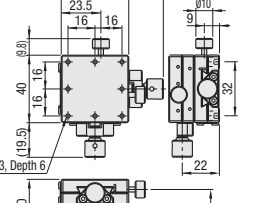

XYFES60 (Standard)

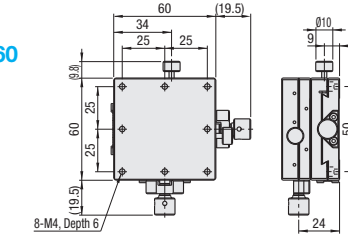

Material: Aluminum Alloy Surface Treatment: Black Anodize

XY-Axis Stages High Precision Stage Existing Product: XYEG (P1693)

Type	Part No.	Clamp Position	Stage Surface (mm)	Travel Distance (mm)	Travel per Knob Rotation (mm)	Load Capacity (N)		Travel Accuracy Straightness	Weight (kg)	Unit Price 1~9 pc(s).	
						Horizontal	Vertical				
XYFES	25	Not Specified (Standard)	25x25	±5	0.5	27.4		50µm	0.09		
	40	R (Reversed)	40x40	±7		33.3					0.16
	60	R (Reversed)	60x60	±8							0.36

Resolution (Vernier Scale Indication): 0.1mm/division

Knob Extension Cover HDEXT12_ (Sold Separately): Ø12 knobs can be extended by installing the cover. P1683 (Caution) Please note that increased knob diameter may interfere with the stage mounting base surfaces.

Ordering Example Part Number XYFES40

Days to Ship

Configure Online

Price Configure Online